



**RELIABLE ELECTRONIC
COMPONENTS PRIVATE LTD.**

PRICE LIST EFFECTIVE FROM 01/04/2017

A-16, 2nd Floor, Raj Industrial Complex, Military Road,
Off. Marol Maroshi Road, Marol, Andheri (E), Mumbai - 400 059.
Phone : 2920 1950 ❖ E-mail : recomswitch@gmail.com

WIPING CONTACTS ROTARY SWITCHES

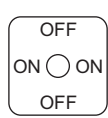
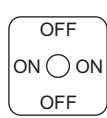
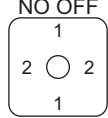
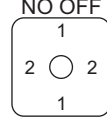
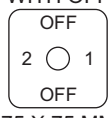
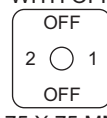
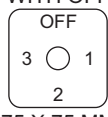
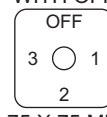
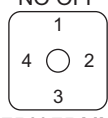
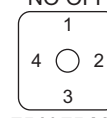

16 AMP. SWITCHES 4-POSITION 90°
Single Phase 250V - Three Phase 440V

25 AMP. SWITCHES 4-POSITION 90°
Single Phase 250V - Three Phase 440V

SWITCHING SEQUENCE	No. OF Poles	AC only TYPE	Price Rs. Ex	AC/DC TYPE	Price Rs. Ex	SWITCHING SEQUENCE	No. OF Poles	AC only TYPE	Price Rs. Ex	AC/DC TYPE	Price Rs. Ex
ON-OFF  75 X 75 MM	1 2 3 4	SPA2116 SPA3216 SPA4316 SPA5416	187 237 284 311	SPD2116 SPD3216 SPD4316 SPD5416	277 311 381 468	ON-OFF  75 X 75 MM	1 2 3 4	SPA3125 SPA5225 SPA7325 SPA9425	278 290 385 489	SPD3125 SPD5225 *SPD8325/LM *SPD10425/LM	342 385 574 676
TWO WAY A NO OFF  75 X 75 MM	1 2 3 4	SPA3116A SPA5216A SPA7316A SPA9416A	231 299 402 477	SPD3116A SPD5216A *SPD8316A/LM *SPD10416A/LM	313 387 568 715	TWO WAY A NO OFF  75 X 75 MM	1 2 3 4	SPA3125A SPA5225A SPA7325A SPA9425A	285 343 469 574	SPD3125A SPD5225A *SPD8325A/LM *SPD10425A/LM	368 489 676 769
TWO WAY B WITH OFF  75 X 75 MM	1 2 3 4	SPA3116B SPA5216B SPA7316B SPA9416B	219 290 412 482	SPD3116B SPD5216B *SPD8316B/LM *SPD10416B/LM	312 385 589 686	TWO WAY B WITH OFF  75 X 75 MM	1 2 3	SPA5125B SPA9225B SPA13325B	299 412 654	SD5125B *SPD10225B/LM *SPD14325B/LM	385 616 880
THREE WAY C WITH OFF  75 X 75 MM	1 2 3 4	SPA3116C SPA6216C SPA9316C SPA12416C	231 311 599 809	SPD3116C *SPD7216C/LM *SPD10316C/LM *SPD13416C/LM	344 482 769 864	THREE WAY C WITH OFF  75 X 75 MM	1 2 3	SPA5125C SPA9225C SPA13325C	322 469 743	SPD5125C *SPD10225C/LM *SPD14325C/LM	427 616 1001
FOUR WAY D NO OFF  75 X 75 MM	1 2 3 4	SPA3116D SPA6216D SPA9316D SPA12416D	250 322 685 809	SPD3116D *SPD7216D/LM *SPD10316D/LM *SPD13416D/LM	359 492 667 973	FOUR WAY D NO OFF  75 X 75 MM	1 2 3	SPA5125D SPA9225D SPA13325D	343 522 852	SPD5125D *SPD10225D/LM *SPD14325D/LM	449 686 1124

10 AMP. SWITCHES 4-POSITION 90°
Single Phase 250V - Three Phase 440V

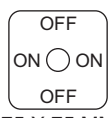
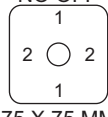
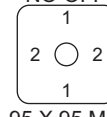
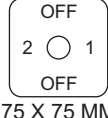
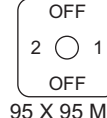
40 AMP. SWITCHES 4-POSITION 90°
Single Phase 250V - Three Phase 440V

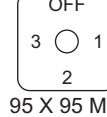
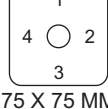
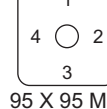
ON - OFF  75 X 75 MM	3 4	SPA4310 SPA5410	261 290	SPD4310 SPD5410	345 427	ON - OFF  95 X 95 MM	1 2 3 4	SPA2140 SPA3240 SPA4340 SPA5440	356 437 519 596	SPD2140 SPD3240 SPD4340 SPD5440	550 646 743 835
TWO WAY A NO OFF  75 X 75 MM	3 4	SPA7310A SPA9410A	366 437	*SPD8310A/LM *SPD10410A/LM	538 624	TWO WAY A NO OFF  95 X 95 MM	1 2 3 4	SPA3140A SPA5240A SPA7340A SPA9440A	455 645 757 949	SPD3140A SPD5240A SPD7340A SPD9440A	665 869 1035 1217
TWO WAY B WITH OFF  75 X 75 MM	3 4	SPA7310B SPA9410B	361 427	*SPD8310B/LM *SPD10410B/LM	517 616	TWO WAY B WITH OFF  95 X 95 MM	1 2 3 4	SPA3140B SPA5240B SPA7340B SPA9440B	435 603 771 927	SPD3140B SPD5240B SPD7340B SPD9440B	644 835 1025 1213
THREE WAY C WITH OFF  75 X 75 MM	3 4	SPA9310C SPA12410C	412 593	*SPD10310C/LM *SPD13410C/LM	600 686	THREE WAY C WITH OFF  95 X 95 MM	1 2 3 4	SPA3140C SPA6240C SPA9340C SPA12440C	450 674 1005 1363	SPD3140C SPD6240C SPD9340C SPD12440C	662 890 1379 1551
FOUR WAY D NO OFF  75 X 75 MM	3 4	SPA9310D SPA12410D	427 592	*SPD10310D/LM *SPD13410D/LM	616 748	FOUR WAY D NO OFF  95 X 95 MM	1 2 3 4	SPA3140D SPA6240D SPA9340D SPA12440D	465 747 1040 1390	SPD3140D SPD6240D SPD9340D SPD12440D	674 915 1418 1620





* Suffix code "LM" indicate Large Mechanism (40/63A). Accordingly Indicating Plate size 95x95mm sq.

* Prefix PA is with square mounting plate

WIPING CONTACTS ROTARY SWITCHES

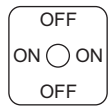
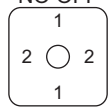
PRICE LIST EFFECTIVE FROM 01/04/2017

63 AMP. SWITCHES 4-POSITION 90° Single Phase 250V - Three Phase 440V

SWITCHING SEQUENCE	No. OF Poles	AC only TYPE	Price Rs. Ex	AC/DC TYPE	Price Rs. Ex
ON-OFF  95 X 95 MM	1	SPA3163	432	SPD3163	636
	2	SPA5263	559	SPD5263	835
	3	SPA7363	759	SPD7363	1020
	4	SPA9463	927	SPD9463	1204
TWO WAY A NO OFF  95 X 95 MM	1	SPA3163A	488	SPD3163A	686
	2	SPA5263A	686	SPD5263A	927
	3	SPA7363A	911	SPD7363A	1154
	4	SPA9463A	1118	SPD9463A	1389
TWO WAY B WITH OFF  95 X 95 MM	1	SPA5163B	596	SPD5163B	835
	2	SPA9263B	927	SPD9263B	1204
	3	SPA13363B	1261	SPD13363B	1578
	4	SPA17463B	1577	-	-
THREE WAY C WITH OFF  95X 95 MM	1	SPA5163C	506	SPD5163C	860
	2	SPA9263C	764	SPD9263C	1259
	3	SPA13363C	1319	SPD13363C	1843
	4	SPA17463C	1596	-	-
FOUR WAY D NO OFF  95X 95 MM	1	SPA5163D	643	SPD5163D	877
	2	SPA9263D	908	SPD9263D	1298
	3	SPA13363D	1389	SPD13363D	1927
	4	SPA17463D	1780	-	-

125 AMP SWITCHES 4 POSITION 90° Single Phase 250V AC Three Phase 440V AC

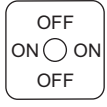

SWITCHING SEQUENCE	ON - OFF		2 WAY NO OFF		2 WAY + OFF	
	No. of Poles	Type	Type	Price Rs. each	Type	Price Rs. each
 Indicating Plate size 95x95 mm sq.	1	XA51125	XA71125A	984	XA71125B	1852
	2	XA82125	XA122125A	1409	XA122125B	3214
	3	XA113125	XA173125A	1950	XA173125B	4413

Switches for any switching programme are also manufactured on request. Switches for DC Supply System available on request.

TERMS

- Prices are each F. O. R. Mumbai (Maharashtra)/ Ex - Works Mumbai (Maharashtra)
- Prices are excluding any Excise Duty, Local/Central Taxes, Octroi charges or any other Government Levies. These are charged extra as applicable at the time of supply.
- Prices are for standard range of switches. Indicating Plates are supplied at extra cost.
- These terms are subject to our standard conditions of sale.
- Prices are subject to change without notice.

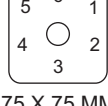
10 & 20 AMP. SWITCHES 6-POSITION 60° - 8 Positions 45° Single Phase 250V - Three Phase 440V

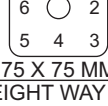
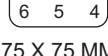
SWITCHING SEQUENCE	No. Of Poles	AC only 10 Amp.	Price Rs.Ex	SWITCHING SEQUENCE	AC only 20 Amp.
FIVE WAY EO  75 X 75 MM	1	SPA4110EO	217	SPA7120EO	373
	2	SPA8210EO	397	SPA14220EO	572
	3	SPA12310EO	616	SPA21320EO/P	810
SIX WAY F  75 X 75 MM	1	SPA4110F	238	SPA7120F	396
	2	SPA8210F	475	SPA14220F	589
	3	SPA12310F	714	SPA21320F/P	823
SEVEN WAY GO WITH OFF  75 X 75 MM	1	SPA5110GO	276	SPA9120GO	475
	2	SPA9210GO	546	SPA17220GO	751
	3	SPA13310GO	789	SPA25320GO/P	1109
EIGHT WAY H  75 X 75 MM	1	SPA5110H	297	SPA9120H	539
	2	SPA9210H	559	SPA17220H/P	824
	3	SPA13310H	823	SPA25320H/P	1177

32 & 63 AMP. SWITCHES AC ONLY 6 - POSITION 60° - 8 Positions 45° Single Phase 250V - Three Phase 440V

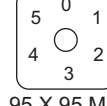
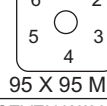
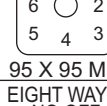
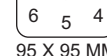
SWITCHING SEQUENCE	No. Of Poles	AC only 32 Amp.	Price Rs.Ex	AC only 63 Amp.	Price Rs.Ex
FIVE WAY EO WITH OFF  95 X 95 MM	1	SPA4132EO	559	SPA7163EO	915
	2	SPA8232EO	852	SPA14263EO	1395
	3	SPA12332EO	1164	SPA21363EO/P	3629
SIX WAY F NO OFF  95 X 95 MM	1	SPA4132F	572	SPA7163F	947
	2	SPA8232F	869	SPA14263F	1457
	3	SPA12332F	1177	SPA21363F/P	2013
SEVEN WAY GO WITH OFF  95 X 95 MM	1	SPA5132GO	589	SPA9163GO	1150
	2	SPA9232GO	897	SPA17263GO/P	1861
	3	SPA13332GO	1272	SPA25363GO/P	2609
EIGHT WAY H NO OFF  95 X 95 MM	1	SPA5132H	607	SPA9163H	1274
	2	SPA9232H	915	SPA17263H/P	1985
	3	SPA13332H	1286	SPA25363H/P	2802

NOTE FOR SURFACE MOUNTING SWITCHES :

Fixing arrangement for Indicating Plate is not provided as a standard. If required same can be provided on specific request at extra cost.









Note : 1. Suffix code 'P' indicates Pistol Grip Handle. 2. Prices of 6/8 Position DC Rotary Switches on request.

WIPING CONTACTS ROTARY SWITCHES

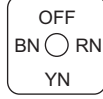
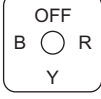
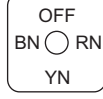
PRICE LIST EFFECTIVE FROM 01/04/2017

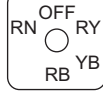
AMMETER SWITCHES

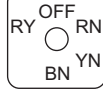
VOLTMETER SELECTOR SWITCHES

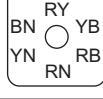
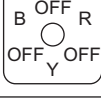
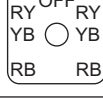
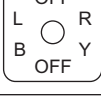
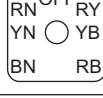
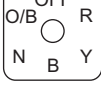
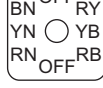
SWITCHING FUNCTION To read by means of a SINGLE AMMETER	Legend Plate 75x75mm	Type	Price Rs. each	SWITCHING FUNCTION To read by means of a SINGLE VOLTMETER	Legend Plate 75x75mm	Type	Price Rs. each
Current through CT's in each Phase with OFF 4 POSITION 90		SPA6310AM	250	Voltage between Phases with OFF 4 POSITION 90		SPA5310VM	227
Current through CT's in each Phase with OFF 4 POSITION 90		SPA10310AM2	851	Voltage between each Phases & Neutral (permanently connected) with OFF 4 POSITION 90		SPA5110VM2	267
Current without CT's in each Phase with OFF 4 POSITION 90		SPA11310AM3	1118	Voltage between each Phases and Neutral (Switched) with OFF 4 POSITION 90		SPA6310VM3	320
Current through CT's in Neutral & in each Phases without OFF 4 POSITION 90		SPA7410AM4	480	Voltage between Phases and between Phase and Neutral with OFF 5 POSITION 90		SPA6410VM4	331
Current without CT's in Neutral & in each Phases without OFF 4 POSITION 90		SPA13410AM5	1170	Voltage between each Phase and Neutral and between Phases with OFF 5 POSITION 90		SPA7410VM5	416
Current through CT's in Neutral & in each Phases without OFF 4 POSITION 90		SPA13410AM6	1170	Voltage between Phases and between each phase and Neutral without OFF 6 POSITION 60		SPA7410VM6	530
Current through CT's in each Phases with an alternate OFF between 2 Phases 6 POSITION 60		SPA6310AM7	416	Voltage between Phases of 2 Supply System with OFF 7 POSITION 45		SPA12610VM7	1000
Current through CT's in each of 3 Phases with leakage or out of balance current with 2 OFFs 6 POSITION 60		SPA8410AM8	480	Voltage between Phases and between each Phase and Neutral with OFF 7 POSITION 45		SPA9410VM8	692
Current through CT's in each of 3 Phases Neutral and Out of balance or leakage current with OFF 6 POSITION 60		SPA10510AM9	552	Voltage between Phases and between each Phase and Neutral with OFF 8 POSITION 45		SPA9410VM9	692

COMBINED AMMETER/VOLTMETER SELECTOR SWITCHES

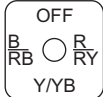
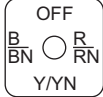
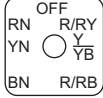
SWITCHING FUNCTION To read by means of a Single AMMETER and VOLTMETER simultaneously only (with Single Switch)	Legend Plate 75x75mm	Type	Price Rs. each
Current in each Phase and Voltage between Phases with Off 4 POSITION 90		SPA10310AVM1	480
Current in each Phase and Voltage between each Phase and Neutral with OFF 4 POSITION 90		SPA10410AVM2	565
Current in each Phase and Voltage between Phases and between each Phase and Neutral with OFF 7 POSITION 45		SPA15410AVM3	1170

Note : CT's are shorted between positions to avoid risk of open circuit conditions.

Terms : 1. Prices are each F.O.R. Mumbai 2. Prices are excluding Govt. Levies - excise duty, sales tax, octroi charges. 3. Prices are subject to change without notice. 4. Terms subject to our standard conditions of sale.

Note : Price of Indicating Plates as described Rs. 26 each. Higher rating on request.







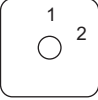
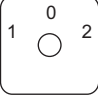

PRICE LIST EFFECTIVE FROM 01/04/2017

Accessories for
ROTARY SWITCHES

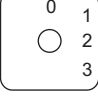
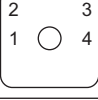
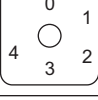

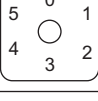

	Price Rs. each
<u>HANDLES :</u>	
Wing Type - Small	19
- Large	30
Pistol Grip (P)/Ball Type (B)	61
<u>INDICATING PLATES :</u>	
Size 75x75 mm square ABS Plastic Moulded Deluxe Type in Light Grey Color.	26
Size 95x95 mm square	34
Note : Embossed Aluminium Anodised Plates Available On Request	
<u>BLOCKED POSITIONS (S) :</u>	
Any combination viz	
TA - One Positions blocked	39
TB - Two Positions blocked	
TC - Inbetween Positions blocked	
Specify the position(s) to be blocked	
<u>LOCKS :</u> Key is removable only in locked position(s)	
Otherwise trapped	343
Lever Type Handle (L) } With E. E. Type Nylon Moulded Body	
Wing Type Handle (W) }	
<u>DOOR INTER LOCKS :</u>	
LOCKABLE :	
Key is removable only in locked position(s)	
otherwise trapped	
Lever Type Handle (DL)	387
Wing Type Handle (DW)	387
specify the position(s) in which interlock should disengage and lock the handle	
<u>NON-LOCKABLE :</u>	
Pistol Grip Handle (DP)	207
Wing Type Handle (DK)	207
Specify the position(s) in which interlock should disengage	
<u>INDICATING PLATES :</u>	
Size 95 x 95 mm square with 36 mm dia hole ABS Plastic Moulded Deluxe for locks and Door interlock Type in Light Grey Color	34
<u>ALSO AVAILABLE</u>	
Indicating Plates size 75x75 mm or 95x95 mm sq. With standard/ non-standard markings.	On Request

ROTARY CAM SWITCHES BUTT CONTACT TYPE
PRICE LIST EFFECTIVE FROM 01/04/2017

SWITCHING SEQUENCE	No. of Poles	10 AMPS SWITCH CODE	Rs.	16 AMPS SWITCH CODE	Rs.	25 AMPS SWITCH CODE	Rs.	32 AMPS SWITCH CODE	Rs.	40 AMPS SWITCH CODE	Rs.
CODE O OFF-ON 2 POSITION 60 	1	C10P 1160	104	C16P 1160	170	PC25P 1160	267	PC32P 1160	333	PC40P 1160	448
	2	C10P 1260	133	C16P 1260	214	PC25P 1260	310	PC32P 1260	391	PC40P 1260	541
	3	C10P 2360	142	C16P 2360	232	PC25P 2360	368	PC32P 2360	461	PC40P 2360	665
	4	C10P 2460	180	C16P 2460	289	PC25P 2460	466	PC32P 2460	561	PC40P 2460	790
CODE B 2 WAY 2 POSITION 60 	1	C10P 116B	128	C16P 116B	214	PC25P 116B	328	PC32P 116B	403	PC40P 116B	551
	2	C10P 226B	172	C16P 226B	277	PC25P 226B	434	PC32P 226B	578	PC40P 226B	824
	3	C10P 336B	217	C16P 336B	353	PC25P 336B	740	PC32P 336B	754	PC40P 336B	1085
	4	C10P 446B	272	C16P 446B	437						
CODE BO 2 WAY + OFF 3 POSITION 60 	1	C10P 116BO	128	C16P 116BO	214	PC25P 116BO	328	PC32P 116BO	422	PC40P 116BO	561
	2	C10P 226BO	172	C16P 226BO	277	PC25P 226BO	434	PC32P 226BO	596	PC40P 226BO	840
	3	C10P 336BO	217	C16P 336BO	353	PC25P 336BO	740	PC32P 336BO	769	PC40P 336BO	1099
	4	C10P 446BO	272	C16P 446BO	437						
CODE C 3 WAY 3 POSITION 60 	1	C10P 216C	149	C16P 216C	232	PC25P 216C	370	PC32P 216C	468	PC40P 216C	637
	2	C10P 326C	217	C16P 326C	353	PC25P 326C	572	PC32P 326C	730	PC40P 326C	989
	3	C10P 536C	321	C16P 536C	510	PC25P 536C	736	PC32P 536C	937	PC40P 536C	1277
	4	C10P 646C	405	C16P 646C	650						
CODE CO 3 WAY + OFF 4 POSITION 45 	1	C10P 214CO	149	C16P 214CO	232	PC25P 214CO	387	PC32P 214CO	489	PC40P 214CO	660
	2	C10P 324CO	217	C16P 324CO	353	PC25P 324CO	589	PC32P 324CO	757	PC40P 324CO	1020
	3	C10P 534CO	321	C16P 534CO	510	PC25P 534CO	736	PC32P 534CO	937	PC40P 534CO	1267
	4	C10P 644CO	405	C16P 644CO	650						
CODE D 4 WAY 4 POSITION 60 	1	C10P 216D	163	C16P 216D	256	PC25P 216D	434	PC32P 216D	578	PC40P 216D	840
	2	C10P 426D	246	C16P 426D	396	PC25P 426D	685	PC32P 426D	925	PC40P 426D	1360
	3	C10P 636D	341	C16P 636D	542	PC25P 636D	965	PC32P 636D	1235	PC40P 636D	1672
	4	C10P 846D	466	C16P 846D	746						
CODE DO 4 WAY + OFF 5 POSITION 60 	1	C10P 316DO	187	C16P 316DO	298	PC25P 316DO	481	PC32P 316DO	616	PC40P 316DO	830
	2	C10P 526DO	322	C16P 526DO	522	PC25P 526DO	736	PC32P 526DO	937	PC40P 526DO	1267
	3	C10P 836DO	448	C16P 836DO	725	PC25P 836DO	994	PC32P 836DO	1277	PC40P 836DO	1702
	4	C10P 1046DO	527	C16P 1046DO	840						
CODE E 5 WAY 5 POSITION 60 	1	C10P 316E	206	C16P 316E	331	PC25P 316E	539	PC32P 316E	660	PC40P 316E	884
	2	C10P 526E	345	C16P 526E	552	PC25P 526E	773	PC32P 526E	989	PC40P 526E	1329
	3	C10P 836E	489	C16P 836E	777	PC25P 836E	1156	PC32P 836E	1478	PC40P 836E	1700
CODE EO 5 WAY + OFF 6 POSITION 60 	1	C10P 316EO	206	C16P 316EO	331	PC25P 316EO	516	PC32P 316EO	660	PC40P 316EO	884
	2	C10P 626EO	365	C16P 626EO	586	PC25P 626EO	773	PC32P 626EO	989	PC40P 626EO	1329
	3	C10P 936EO	489	C16P 936EO	777	PC25P 936EO	1156	PC32P 936EO	1478	PC40P 936EO	1998
CODE F 6 WAY 6 POSITION 60 	1	C10P 316F	216	C16P 316F	341	PC25P 316F	539	PC32P 316F	792	PC40P 316F	1099
	2	C10P 626F	402	C16P 626F	637	PC25P 626F	942	PC32P 626F	1257	PC40P 626F	1939
	3	C10P 936F	578	C16P 936F	915	PC25P 936F	1286	PC32P 936F	1702	PC40P 936F	2553

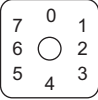
ROTARY CAM SWITCHES BUTT CONTACT TYPE

PRICE LIST EFFECTIVE FROM 01/04/2017

SWITCHING SEQUENCE	No. of Poles	10 AMPS SWITCH CODE	Rs.	16 AMPS SWITCH CODE	Rs.	25 AMPS SWITCH CODE	Rs.	32 AMPS SWITCH CODE	Rs.	40 AMPS SWITCH CODE	Rs.
CODE G 7 WAY 7 POSITION 45 	1 2 3	C10P 414G C10P 724G C10P 1134G	261 460 643	C16P 414G C16P 724G C16P 1134G	426 736 947	PC25P 414G PC25P 724G PC25P 1134G	847 1286 1535	PC32P 414G PC32P 724G PC32P 1134G	1159 1594 1968	PC40P 414G PC40P 724G PC40P 1134G	1362 1998 2763
CODE GO 7 WAY + OFF 8 POSITION 45 	1 2 3	C10P 414GO C10P 824GO C10P 1234GO	267 466 650	C16P 414GO C16P 824GO C16P 1234GO	437 746 1040	PC25P 414GO PC25P 824GO PC25P 1234GO	637 1286 1545	PC32P 414GO PC32P 824GO PC32P 1234GO	851 1594 1968	PC40P 414GO PC40P 824GO PC40P 1234GO	1064 1998 2459
CODE H 8 WAY 8 POSITION 45 	1 2 3	C10P 414H C10P 824H C10P 1234H	276 507 692	C16P 414H C16P 824H C16P 1234H	447 757 1053	PC25P 414H PC25P 824H PC25P 1234H	692 1364 1734	PC32P 414H PC32P 824H PC32P 1234H	926 1618 2313	PC40P 414H PC40P 824H PC40P 1234H	1374 2443 2764
CODE M 12 WAY 12 POSITION 30 		ON REQUEST		C16P 613M C16P 1223M	660 1159	PC25P 613M PC25P 1223M	1040 1810	PC32P 613M PC32P 1223M	1257 2314	PC40P 613M PC40P 1223M	1982 3629
CODE RO REVERSING + OFF 3 POSITION 60 	2 3	C10P 226RO C10P 336RO	170 196	C16P 226RO C16P 336RO	273 320	PC25P 226RO PC25P 336RO	403 460	PC32P 226RO PC32P 336RO	489 539	PC40P 226RO PC40P 336RO	692 809

AMMETER SELECTOR SWITCHES

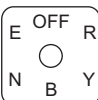
CODE to read current through CT's in each phase + OFF 4 Position 90		10 AMPS		16 AMPS	
	1	C10P 439AM	227	C16P 439AM	361
CODE O-R-Y-B-N-E 6 POSITION 60 	2	C10P 656AM	385	C16P 656AM	522

VOLTMETER SELECTOR SWITCHES

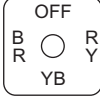
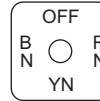
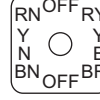
CODE to read Voltage between phase + OFF 4 Position 90		10 AMPS		16 AMPS	
	3	C10P 339VM	158	C16P 339VM	256
CODE to read Voltage between each phase and Neutral + OFF 4 Position 90 	3	C10P 349VM	251	C16P 349VM	403
CODE O-R-Y-B-N-O-BN-YN-RN 8 Position 45 	3	C10P 444VM	289	C16P 444VM	459

Note: 1) CT's are shorted between positions to avoid risk of open circuit conditions. 2) Above switches with lever or Tee center key lock assembly available at extra price of Rs. 343each. 3) Switches with Padlocking feature - Yellow cup & Red knob available at extra Price for 10 & 16 Amps. Rs. 161 & 32/40 Amps. Rs. 192each. 4) 6/10/16 Amps. Switches available with center key lock suitable for single hole mounting of 22.5 dia. Prices on request. 5) Prices of 20 & 50 Amps. Cam switches - On Request. 6) OFF/ON & FOR./REV./ Switches available in Enclosure. 7) 10 & 16A Cam switches are available for Mom. Contacts in lieu of Push Button switches. 8) Above range of Cam switches available with SAFETY FINGER PROOF PACKETS - Prices on request. 9) All Rotary Cam Switches are supplied with Grey Colored escution plates with Black Screen Printed suitable legends. Yellow escution with RED knobs on request at extra cost.

TERMS : 1) Prices are each F.O.R. Ex-Mumbai works. 2) Prices are excluding Excise Duty, Sales Tax, Octroi charges or any other Govt. Levies. These are charged extra as applicable at the time of supply. 3) Prices are for standard range of Switches inclusive of indicating plates. 4) These terms are subject to our standard conditions of sale. 5) Prices are subject to change without notice.

ROTARY CAM SWITCHES BUTT CONTACT TYPE

PRICE LIST EFFECTIVE FROM 01/04/2017

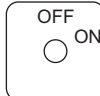
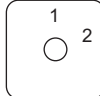
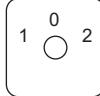
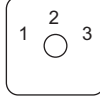
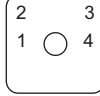
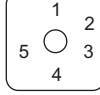
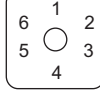
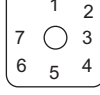
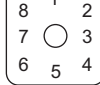
SWITCHING SEQUENCE	No. of Poles	63 AMPS SWITCH CODE	PRICE Rs.	80 AMPS SWITCH CODE	PRICE Rs.	100 AMPS SWITCH CODE	PRICE Rs.	125 AMPS SWITCH CODE	PRICE Rs.
CODE O OFF-ON 2 POSITION 60 	1	PC63P 1160	668	PC80P 1160	840	PC100P 1160	1053	PC125P 1160	1362
	2	PC63P 1260	840	PC80P 1260	1057	PC100P 1260	1303	PC125P 1260	1706
	3	PC63P 2360	1099	PC80P 2360	1388	PC100P 2360	1864	PC125P 2360	2314
	4	PC63P 2460	1274	PC80P 2460	1592	PC100P 2460	1982	PC125P 2460	2672
CODE B 2 WAY 2 POSITION 60 	1	PC63P 116B	810	PC80P 116B	1015	PC100P 116B	1257	PC125P 116B	1652
	2	PC63P 226B	1274	PC80P 226B	1592	PC100P 226B	1982	PC125P 226B	2574
	3	PC63P 336B	1736	PC80P 336B	2169	PC100P 336B	2704	PC125P 336B	3513
	4	PC63P 436B	2148	PC80P 436B	2734	PC100P 436B	3428	PC125P 436B	4453
CODE BO 2 WAY + OFF 3 POSITION 60 	1	PC63P 116BO	840	PC80P 116BO	1057	PC100P 116BO	1303	PC125P 116BO	1718
	2	PC63P 226BO	1286	PC80P 226BO	1607	PC100P 226BO	2025	PC125P 226BO	2601
	3	PC63P 336BO	1760	PC80P 336BO	2184	PC100P 336BO	2748	PC125P 336BO	3544
	4	PC63P 446BO	2149	PC80P 446BO	2734	PC100P 446BO	3428	PC125P 446BO	4453
CODE C 3 WAY 3 POSITION 60 	1	PC63P 216C	1267	PC80P 216C	1607	PC100P 216C	1982	PC125P 216C	2601
	2	PC63P 326C	1722	PC80P 326C	2184	PC100P 326C	2704	PC125P 326C	3544
	3	PC63P 536C	2691	PC80P 536C	3417	PC100P 536C	4285	PC125P 536C	5567
	4	PC63P 646C	3149	PC80P 646C	3994	PC100P 646C	5010	PC125P 646C	6506
CODE D 4 WAY 4 POSITION 60 	1	PC63P 216D	1257	PC80P 216D	1592	PC100P 216D	1982	PC125P 216D	2574
	2	PC63P 426D	2184	PC80P 426D	2736	PC100P 426D	3416	PC125P 426D	4442
	3	PC63P 636D	3149	PC80P 636D	3154	PC100P 636D	5010	PC125P 636D	6506
	4	PC63P 846D	4137	PC80P 846D	5253	PC100P 846D	6438	PC125P 846D	8372
CODE E 5 WAY 5 POSITION 60 	1	PC63P 316E	1722	PC80P 316E	2184	PC100P 316E	2704	PC125P 316E	3543
	2	PC63P 526E	2691	PC80P 526E	3417	PC100P 526E	4285	PC125P 526E	5567
	3	PC63P 836E	4137	PC80P 836E	5253	PC100P 836E	7311	PC125P 836E	8372
CODE F 6 WAY 6 POSITION 60 	1	PC63P 316F	1750	PC80P 316F	2184	PC100P 316F	2748	PC125P 316F	3543
	2	PC63P 626F	3197	PC80P 626F	3992	PC100P 626F	4991	PC125P 626F	6493
	3	PC63P 936F	4573	PC80P 936F	5804	PC100P 936F	7311	PC125P 936F	9467
CODE G 7 WAY 7 POSITION 45 	1	PC63P 414G	1750	PC80P 414G	2734	PC100P 414G	3428	PC125P 414G	4453
	2	PC63P 724G	3197	PC80P 724G	4552	PC100P 724G	5731	PC125P 724G	7445
	3	PC63P 1134G	5563	PC80P 1134G	7065				
CODE H 8 WAY 8 POSITION 45 	1	PC63P 414H	2196	PC80P 414H	2748	PC100P 414H	3427	PC125P 414H	4453
	2	PC63P 824H	4046	PC80P 824H	5048	PC100P 824H	6319	PC125P 824H	8199
	3	PC63P 1234H	5976	PC80P 1234H	7592				

TERMS :

- 1) Prices are each F.O.R. Ex-Mumbai works. 2) Prices are excluding Excise Duty, Sales Tax, Octroi charges or any other Govt. Levies. These are charged extra as applicable at the time of supply. 3) Prices are for standard range of Switches inclusive of indicating plates. 4) These terms are subject to our standard conditions of sale. 5) Prices are subject to change without notice.

Notes :

- 1) Switches with Padlocking feature - Yellow cup & Red knob available at extra Price for 63/80 Amps. Rs. 252/- & 100/125 Amps. Rs. 336/-
- 2) Above switches with Lever or Tee type center keylock assembly available at extra Price of Rs. 340/- each.

PRICE LIST EFFECTIVE FROM 01/04/2017

MOTOR CONTROL SWITCHES - MC SERIES

Recessed Terminals accessible from Top side

25 Amps. Packet size 56mm dia.
63/80 Amps. Packet size 80mm dia.

32/40 Amps. Packet size 72 x 80 mm.
100/25 Amps. Packet size 110 x 100mm.

SWITCHING SEQUENCE (3 Pole)	△INDICATING DIAL MARKINGS	DEGREE THROW	NO. OF POSITIONS	RATED CURRENT IN AMPS. AT 440V AC 50 HZ.	OPEN EXECUTION CODE X	PRICE Rs. EACH	SHEET STEEL ENCLOSURE CODE E/S	PRICE Rs. EACH
OFF - ON	1 - 0 or ON - OFF	45	2	25	MC25x20	361	MC25E20	578
				32	MC32x20Z	448	MC32S20Z	696
				40	MC40x20Z	667	MC40S20Z	956
				63	MC63x20	1173	MC63E20	1702
				80	MC80x20	1418	MC80E20	1947
				100	MC100x20Z	1663	MC100S20Z	2191
				125	MC125x20Z	2314	MC125S20Z	2829
REVERSING	1 - 0 - 1	45	3	25	MC25x3K	495	MC25E3K	708
				32	MC32x3KW	578	MC32S3KW	824
				40	MC40x3KW	868	MC40S3KW	1156
				63	MC63x3K	1750	MC63E3K	2275
				80	MC80x3K	2099	MC80E3K	2615
				100	MC100x3KW	2414	MC100S3KW	2935
				125	MC125x3KW	3660	MC125S3KW	4191
STAR - DELTA	△ Y - O	45	3	25	MC25x4SD	651	MC25E4SD	866
				32	MC32x4SD	783	MC32S4SD	1026
				40	MC40x4SD	1113	MC40S4SD	1418
				63	MC63x4SD	2112	MC63E4SD	2638
				80	MC80x4SD	2544	MC80E4SD	3062
				100	MC100x4SD	2965	MC100S4SD	3489
				125	MC125x4SD	4655	MC125S4SD	5189
SYSTEM SELECTOR 1 LOAD 2 SYSTEMS	2 - 0 - 1	45	3	25	MC25x3C	538	MC25E3C	754
				32	MC32x3CU	578	MC32S3CU	824
				40	MC40x3CU	868	MC40S3CU	1155
				63	MC63x3C	1750	MC63E3C	2275
				80	MC80x3C	2099	MC80E3C	2615
				100	MC100x3CU	2414	MC100S3CU	2947
				125	MC125x3CU	3660	MC125S3CU	4191
2 SPEED POLE CHANGING 1 SEPARATE WINDINGS	2 - 1 - 0	45	3	25	MC25x3PC	538	MC25E3PC	751
				32	MC32x3PC	578	MC32S3PC	824
				40	MC40x3PC	868	MC40S3PC	1155
II DAHLANDER WINDINGS	2 - 1 - 0	45	3	25	MC25x4PC	651	MC25E4PC	868
				32	MC32x4PC	783	MC32S4PC	1027
				40	MC40x4PC	1113	MC40S4PC	1340
2 SPEED REVERSING POLE CHANGING	2 - 1 - 0 - 1 - 2	45	5	25	MC25x7PCK	956	-	-
				32	MC32x7PCK	1130	-	-
				40	MC40x7PCK	1607	-	-

MOTOR DUTY CONTROL SWITCHES - MDC SERIES (WITH DOOR INTERLOCK FACILITY)

DESCRIPTION	Switching Sequence 2 Position 90 On-Off					
	2 POLE		3 POLE With Neutral Link		4 POLE	
	TYPE	PRICE Rs. EACH	TYPE	PRICE Rs. EACH	TYPE	PRICE Rs. EACH
25 Amps	MDC25B1290/DP1	609	MDC25B2390/DP1	667	MDC25B2490/DP1	740
32 Amps	MDC32B1290/DP1	678	MDC32B2390/DP1	752	MDC32B2490/DP1	852
40 Amps	MDC40B1290/DP1	840	MDC40B2390/DP1	970	MDC40B2490/DP1	1099
63 Amps	MDC63B1290/DP1	1156	MDC63B2390/DP1	1432	MDC63B2490/DP1	1607
80 Amps	MDC80B1290/DP1	1418	MDC80B2390/DP1	1736	MDC80B2490/DP1	1939
100 Amps	MDC100B1290/DP1	1663	MDC100B2390/DP1	2082	MDC100B2490/DP1	2329
125 Amps	MDC125B1290/DP1	2012	MDC125B2390/DP1	2618	MDC125B2490/DP1	2965

TERMS :

1) Prices are each F.O.R. Mumbai. 2) Prices are excluding Excise Duty, Local/Central Taxes, Octroi charges or any other Govt. Levies. These are charged extra as applicable at the time of supply. 3) Prices are for standard range of Switches. 4) These terms are subject to our standard conditions of sale. 5) Prices are subject to change without notice. 6) This supercedes our previous price list dated 1401/04/2014.

Notes :

- Switches with Padlocking feature - Yellow Recessed cup & Red knob available Price for 25/32/40 Amps. Rs. 192/-, 63/80 Amps. Rs. 253/- & 100/125 Amps. Rs.336/- extra.
- Prices of 50 Amps. Motor Control switches - ON REQUEST.
- Switches with Lever or Tee type Lock assembly available at extra price of Rs. 334/- each.

MANUFACTURED BY

RELIABLE ELECTRONIC COMPONENTS PVT. LTD.

'A' WING 16 , 2ND FLOOR, RAJ INDUSTRIAL COMPLEX, MILITARY ROAD, MAROL, ANDHERI (EAST), MUMBAI- 400 059

Tel. : 2920 1950 Email : recomswitch@gmail.com



PRICE LIST EFFECTIVE FROM 01/04/2017

RBC CONTROL SWITCHES FOR BREAKER APPLICATIONS

MECHANISMS :

List Price Rs. each

RBC 25 Amps	RBC 32 Amps	RBC 40 Amps
----------------	----------------	----------------

A. Spring Return with Pistol Grip Handle and Plate	507	525	552
B. Spring Return with Lost Motion Device	645	692	736
C. Spring Return with Lost Motion Device and Sequence Locking	736	829	921
D. Spring Return with Sequence Locking	645	692	736
E. Stay Put	250	268	295

Note : Specify indexing degree standard is 45
(options 60° & 90°)

PACKETS/CONTACTS :

Contacts per packet - 1 N/o 1 N/c (2 electrical ways) Main or Lost Motion	201	277	343
--	-----	-----	-----

LOCKS/BARREL TYPE : (BLACK G. F. NYLON BODY)

1. Lever type handle (L) : E. E. Type	350	350	350
2. Wing type handle (W) : SANTON Type	350	350	350

Note : Indicating Plates marking : Trip - Neutral - Close Size 88 X 75 mm
Non - Standard marking on request at extra cost.

- Terms :
1. Prices are each F. O. R. Mumbai.
 2. Govt. Levies charged extra as applicable.
 3. Subject to standard conditions of sale.

MANUFACTURED BY

RELIABLE ELECTRONIC COMPONENTS PVT. LTD.

'A' WING 16 , 2ND FLOOR, RAJ INDUSTRIAL COMPLEX, MILITARY ROAD, MAROL, ANDHERI (EAST), MUMBAI- 400 059

Tel. : 2920 1950 Email : recomswitch@gmail.com

RELIABLE ELECTRONIC COMPONENTS PVT LIMITED

PRICE LIST EFFECTIVE FROM 01/04/2017

Toggle Switches 10Amps/250VAC.

15Amps /250VAC

Sr. No.	Switching Sequence	Single Pole	Price Each Rs	Double Pole	Price Each Rs	Single Pole	Price Each Rs	Double Pole	Price Each Rs
1	Off-On	RT121B	61	RT241B	88	MRT121B	84	MRT241B	112
2	2 Way No Off	RT132B	68	RT262B	99	MRT132B	96	MRT262B	126
3	2Way With Off	RT133B	68	RT263B	103	MRT133B	108	MRT263B	130
4	2 Way Without Off (Mom)	RT134B	82	RT264B	114	MRT134B	119	MRT264B	149
5	2Way With Off (Both Mom)	RT135B	83	RT265B	119	MRT135B	129	MRT265B	159
6	Off-On (Mom)	RT126B	66	RT246B	95	MRT126B	105	MRT246B	126
7	2Way No Off (Mom)	RT137B	76	RT267B	106	MRT137B	110	MRT267B	137

Toggle Switches 10Amps/250VAC.

15Amps /250VAC

Sr. No.	Switching Sequence	Three Pole	Price Each Rs	Four Pole	Price Each Rs	Three Pole	Price Each Rs	Four Pole	Price Each Rs
1	Off-On	RT361B	137	RT481B	151	MRT361B	176	MRT481B	204
2	2 Way No Off	RT392B	149	RT4122B	171	MRT392B	200	MRT4122B	209
3	2Way With Off	RT393B	159	RT4123B	183	MRT393B	208	MRT4123B	226

Micro Switches (N-O/N-C)

10Amps 250VAC.

Description	Type Nos / Screw terminal	Price Rs. Each
Miniature Basic Switch (Std. Op Force 400Gms)	R3BOW	50
Basic Switch with Actuators (Integral)		
Short Plain Lever	R3BOW-01	64
Short Roller Lever	R3BOW-02	66
Medium Plain Lever	R3BOW-03	68
Medium Roller Lever	R3BOW-04	72
Extended Plain Lever	R3BOW-05	72
Medium Lever with Notch	R3BOW-38	72

Basic Switch with Actuators (Aux)

Plain Leaf	R3BOW-06	64
Roller Leaf	R3BOW-07	68
Hinged Lever	R3BOW-08	72
Hinged Lever With roller	R3BOW-09	72
Extended Hinged Lever	R3BOW-10	72
Extended Hinged Lever with Roller	R3BOW-11	76
Finger Push Button SP	R3BOW-12	76
Finger Push Button D.P	R3BOW-13	149
Push Button S.P	R3BOW-15	76
Push Button D.P	R3BOW-16	149
Thumb Press Button	R3BOW-18	131
Toggle Action	R3BOW-50	76

- Note :
- 1) Above listed switches are with standard screw type terminals Code B. substitute A for solder terminal and C for push on terminals.
 - 2) 3 & 4 pole switches are suitable for voltages upto 250VAC
 - 3) Prices for 20Amps Toggle switches on request
 - 4) Micro Switches comply with IS : 6089
 - 5) Toggle Switches comply with IS 3452 part I, II and III

Terms : 1) Above prices are each F.O.R Mumbai Works, subject to excise duty, S.T or CST as applicable

MANUFACTURED BY

RELIABLE ELECTRONIC COMPONENTS PVT. LTD.

'A' WING 16 , 2ND FLOOR, RAJ INDUSTRIAL COMPLEX, MILITARY ROAD, MAROL, ANDHERI (EAST), MUMBAI- 400 059

Tel. : 2920 1950 Email : recomswitch@gmail.com